

Getting started

Before you begin to assemble Abstracta units, compare the packing slip to all components received. Please read all instructions before beginning.

We recommend using a small amount of non-corrosive lubricant such as WD-40[®] or 3-in-1 oil on the connector tips **prior** to assembly. This makes both assembly and disassembly easier. Wipe off any excess lubricant with a soft cloth or paper towel.

Recommended Tools

- Short piece of 2"x 4" wood (to protect floor and absorb shock)
- Non-corrosive lubricant
- Safety glasses and gloves



Nylon Mallet (913)



Disconnect Tool (915)



Extractor Rod (EX-ABS)

Parts List

- | | |
|-------------------------|---------------------------|
| 4 - 3T connectors | 12 - shelf brackets (620) |
| 8 - 4T connectors | 12 - clear bumpers (012) |
| 4 - 4.69" tubes (130) | 4 - plastic glides (3506) |
| 8 - 15.08" tubes (395) | 3 - glass shelves (1717) |
| 12 - 17.68" tubes (460) | |

Assembly

Step One

Lay out all the parts and components and locate the nylon mallet. This design includes three different tube lengths and two different types of connectors.

Step Two - Abstracta "Bones"

A single tube with the inserted connectors is considered a "bone."

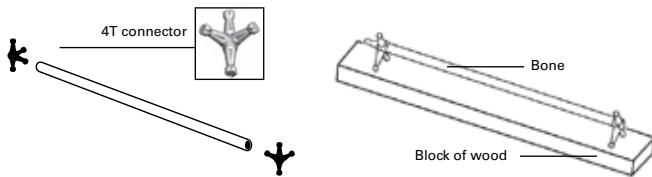

To assemble a bone, insert connectors into a 17.68" (460) tube making sure the connectors are square to each other. This is shown with the piece of wood in the diagram. Partially tap connectors into tubes. Once you have confirmed that both ends are correctly placed, hammer until connector is flush with the tube.

Follow this procedure of making "bones" throughout assembly.

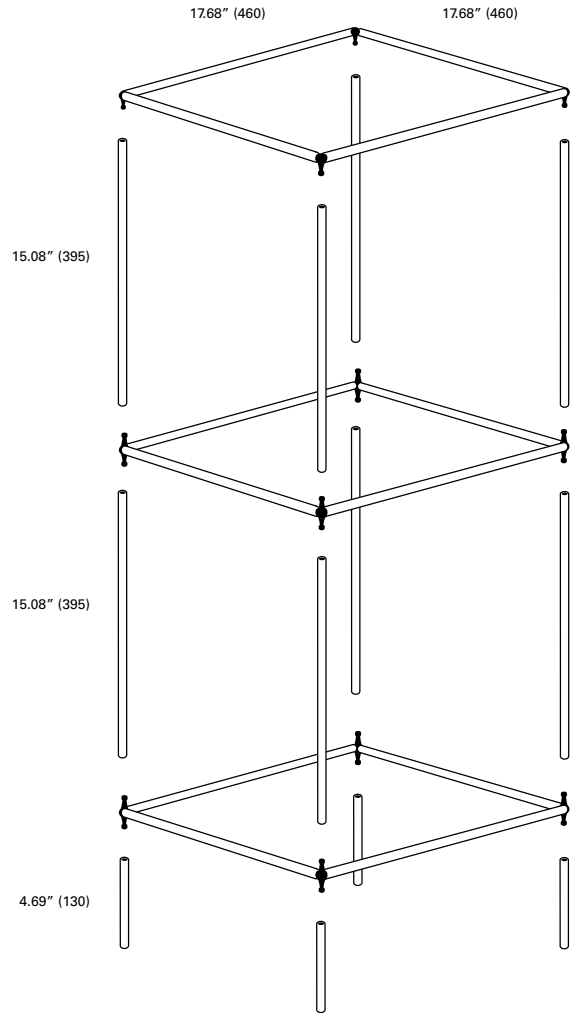

Step Three - Horizontal Shelf Frames

For every square section of an Abstracta unit, only the two tubes which create the depth of the square are "bones." Intermittent tubes are added to make a horizontal square frame.

Top Frame Parts List

- 4 - 3T connectors
- 4 - 17.68" tubes (460)

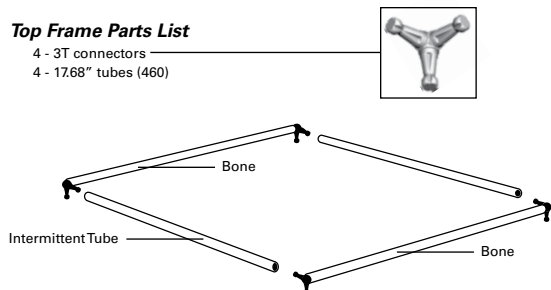



Lower Frame Parts List

- 4 - 4T connectors
- 4 - 17.68" tubes (460)

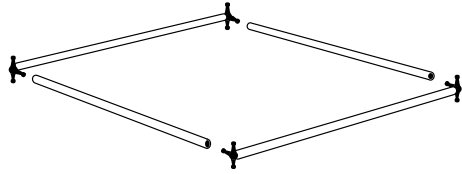
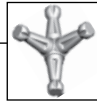

Assemble all of the horizontal square frames using connectors and 17.68" (460) tubes. Each frame includes two bones and two intermittent tubes. The top frame section includes 3T connectors and the lower frame sections include 4T connectors.

Step Four - Building the Tower

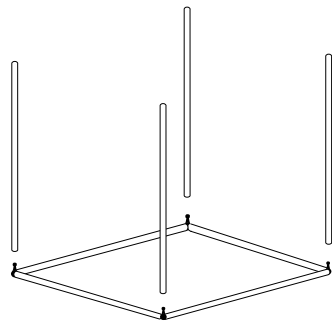

Place top frame section on floor with exposed connectors up. Hammer four 15.08" (395) vertical tubes onto connectors leaving no space between tubes and connectors.

Place a lower frame section onto the tubes. Gently tap in the frame slightly by about 1/4" to insert connector arm onto the upright tubes.

Once all connectors are in place, hammer them half way as some may not remain in place. Go over them once more, making them flush with the tubes. This progression is to avoid stress on the connector arms.

Step Five - Repeat Previous Steps

Hammer in the second set of vertical tubes and then the next frame repeating the same procedure until finished.

Step Six - Legs

Before adding the tower legs to your étagère, confirm there is no space between the tubes and connectors. Place the 4.69" (130) legs on last and hammer them so they are flush. Legs are **permanent** and not recommended for removal.

Leg Glide Parts List

- 4 - Plastic Glides (506)

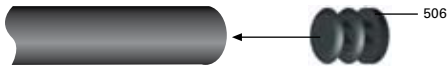

Confirm the unit is correctly assembled. Push the plastic glides (506) into the short tubes. All open tubes should have plastic glides inserted. Do not insert the plastic glides until after the unit is assembled. They are not designed to be removed. Hammering the unit once they are in place may cause them to go in the tubes. Therefore it is important that this is a last step in the construction of your unit.

Caution

Before moving the display or placing shelving or graphics, make sure that all tubes are hammered completely onto the connector arms. Leave no space between the tube and the shoulder of the connector arms. Due to the tight fit the tube ends can scrape a bit of finish off the connector shoulders. Remove the small splinters with the flat end of your nylon mallet. **Bare hands are not recommended as the splinters may be sharp.**

Step Seven - Shelving Placement

When the unit assembly is complete and the structure is upright, carry the unit to the proper place. Attach the asymmetrical brackets (620) and any other accessories before installing shelving. The bumpers (012) are placed in the center of the shelf brackets. These protect your glass from breaking and make for a more secure fit for shelving.

Corner Bracket / Glass Shelf Parts List (per shelf)

- 4 - Shelf Brackets (620)
- 4 - Clear Vinyl Bumpers (012)
- 1 - Glass Shelf (1717)

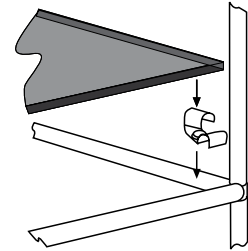

Troubleshooting

Although the connectors are durable zinc casting, you will be assembling them with a nylon mallet. Disassembling units with the mallet will break connectors and is not recommended.

If a connector arm has broken off at the base of the joint and is stuck in the tube, it is preferable to knock it out from the opposite end with a 5/16" diameter steel rod that is longer than the tube. The 36" extractor rod (EX-ABS) is recommended for this.

If the opposite end is attached to another connector, try to knock the broken arm far enough into the tube with a screwdriver and mallet so that a replacement connector can then fit in its place.

Disassembly and the Disconnect Tool

We strongly recommend using our Disconnect Tool (915) for taking Abstracta apart. Similar to a slide hammer, this tool allows for an even distribution of pressure on the connection. Using the mallet or a hammer to disassemble increases the risk of breaking connectors.

To use the tool, firmly grasp the tube and position it in the channel of the Disconnect Tool with the larger end of the tool facing the connector. Rotate the tool to contact the flat end of the tool against one or more connector arms. Strike the connector arms with the tool until loose. Point the tube down so the connector will not hit anything when disconnected.

